

SPECIFICATIONS FOR T3CCW SERIES

Full Colour LED

Model: EMC3030

Part No: T3CCW013S-xxxxxx



Features:

- * High lumen output and efficacy
- * Designed for high current operation
- * Low thermal resistance
- * Pb-free reflow soldering application



Applications

- * Outdoor lighting
- * Architectural lighting

Part Numbering System

T -

X1 X2 X3 X4 X5 X6 X7 X8 X9 X10

Item Number Code	Description	Content
X1	Type code	1S:1010; 1A:1919; 20:2016; 3B:3014; 28:2835 34:3020; 3C:3030; 5C:5050; 7C:7070; 1D:100100; 19: Ceramic 3535; 15: Ceramic 5050; 11: Ceramic 1616.
X2	CCT code	BL: blue ; GR : green; YE : yellow; RE : red; PA: PC Amber ; CW:RGB; FW: RGBW
X3	Color Rendering	0:clour or mix colour
X4	No. of serial chip	1-Z.
X5	No. of parallel chip	1-Z.
X6	Component code	A-Z.
X7	Color Code	M:ANSI; F:ERP; R:85°C ANSI; T:105°C ANSI; B:Backlighting; Q:Others;AT:Tospo
X8	Internal code1	\
X9	Internal code2	\
X10	Spare code	\

Electro Optical Characteristics, IF = 150mA

Clour	Luminous Flux	
	Min.	Max.
Red	22	28
Green	44	51
Blue	7	12

- * Tolerance of measurements of the Luminous Flux is $\pm 7\%$.
- * Correlated Color Temperature is derived from the CIE 1931 Chromaticity diagram.

Absolute Maximum Ratings at Ta=25°C

Item	Symbol	Colour	Absolute Maximum Rating	Unit
Forward current	I_F	Red/Green/Blue	180	mA
Pulse Forward current	I_{FP}	Red/Green/Blue	250	mA
Power Dissipation	P_D	Red	468	mW
		Green	648	
		Blue	648	
Reverse Voltage	V_R	Red/Green/Blue	5	V
Operating Temperature	T_{opr}	/	-40~+85	°C
Storage Temperature	T_{stg}	/	-40~+105	°C
Soldering Temperature	T_{sld}		Reflow Soldering: 230°C or 260°C for 10sec	

- * I_{FP} condition with Pulse: Width $\leq 100\mu s$, Duty cycle $\leq 1/10$.
- * LED's properties might be different from suggested values like above and below tables if operation condition will be exceeded our parameter range. Care is to be taken that power dissipation does not exceed the absolute maximum rating of the product.
- * All measurements were made under the standardized environment of Lightning LED.

Electrical/Optical Characteristics at Ta=25°C

Item	Symbol	Colour	Min.	Typ.	Max.	Unit	Condition
Forward Voltage	V _F	Red	1.6	-	2.6	V	I _F =150mA
		Green	2.6	-	3.4		
		Blue	2.6	-	3.4		
Reverse Current	I _R	Red/Green/Blue	-	-	10	μA	V _R =5V
View Angle	2θ _{1/2}	/	-	120	-	°	I _F =150mA
Thermal resistance	(R _{th j-sp})	Red/Green/Blue	-	5	-	°C/W	I _F =150mA
Electrostatic Discharge	ESD	/	1000	-	-	V	HBM

- * Tolerance of measurements of the Forward Voltage is ±0.1V.
- * 2θ_{1/2} is the off-axis where the luminous intensity is 1/2 of the peak intensity.
- * R_{th j-sp} is the thermal resistance from LED junction to solder point on MCPCB with electrical power

Bin Structure

Dominant Wavelength Ranks, IF = 150mA, Ta =25°C

Colour	Code	Min.	Max.	Unit	Colour	Code	Min.	Max.	Unit
Red	RB2	615	620	nm	Blue	BB3	450	452.5	nm
	RC1	620	625	nm		BB4	452.5	455	nm
	RC2	625	630	nm		BB5	455	457.5	nm
Green	GC3	520	522.5	nm		BB6	457.5	460	nm
	GC3	522.5	525	nm		BC3	460	462.5	nm
	GC3	525	527.5	nm		BC4	462.5	465	nm
	GC3	527.5	530	nm		BC5	465	467.5	nm
	GC3	530	532.5	nm		BC6	467.5	470	nm
	GC3	532.5	535	nm					

*Tolerance of measurements of the WD is $\pm 1\text{nm}$

Luminous Flux Ranks, IF = 150mA, Ta =25°C

Colour	Code	Min.	Max.	Unit
Red	DR0	22	28	Lm
Green	DG0	44	51	Lm
Blue	DB0	7	12	Lm

*Tolerance of measurements of the Luminous Flux is $\pm 7\%$

Forward Voltage Ranks, IF = 150mA, Ta =25°C

Code	Min.	Max.	Unit
AB2	1.8	2.0	V
AC1	2.0	2.2	V
AC2	2.2	2.4	V
AD1	2.4	2.6	V
AD2	2.6	2.8	V
AE1	2.8	3.0	V
AE2	3.0	3.2	V
AF1	3.2	3.4	V

*Tolerance of measurements of the Forward Voltage is $\pm 0.1\text{V}$

Fig 1. Color Spectrum, Ta = 25°C

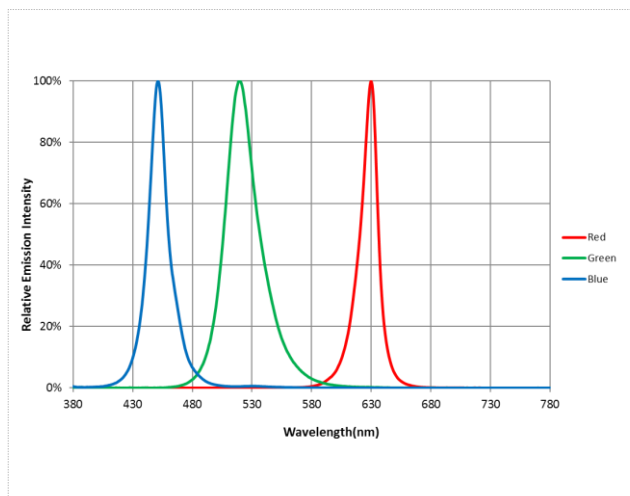

Fig 2. Viewing Angle Distribution, Ta = 25°C

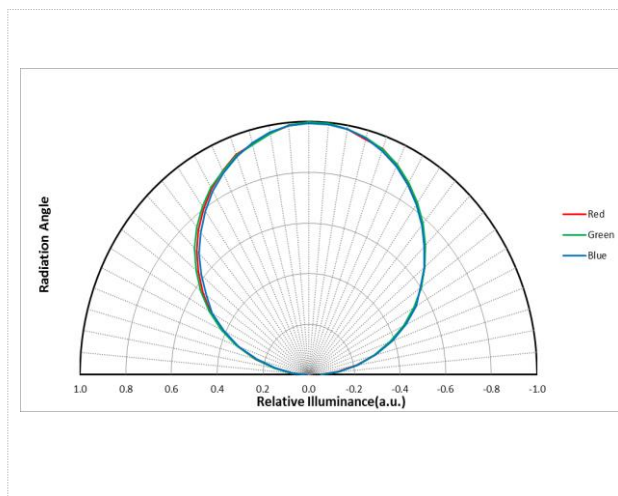

Fig 3. Forward Current vs. Relative Intensity, Ta = 25°C

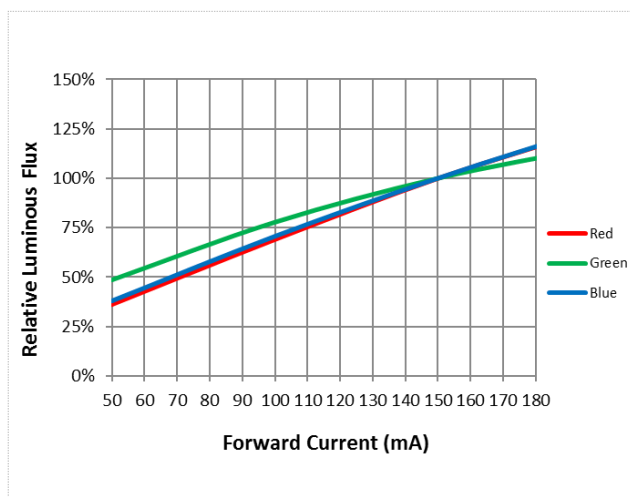

Fig 4. Forward Current vs. Forward Voltage, Ta = 25°C

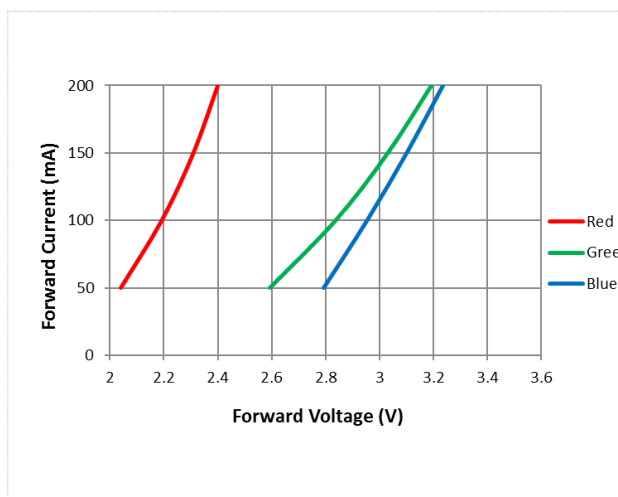

Fig 5. Ambient Temperature vs. Relative Luminous flux (IF=150mA)

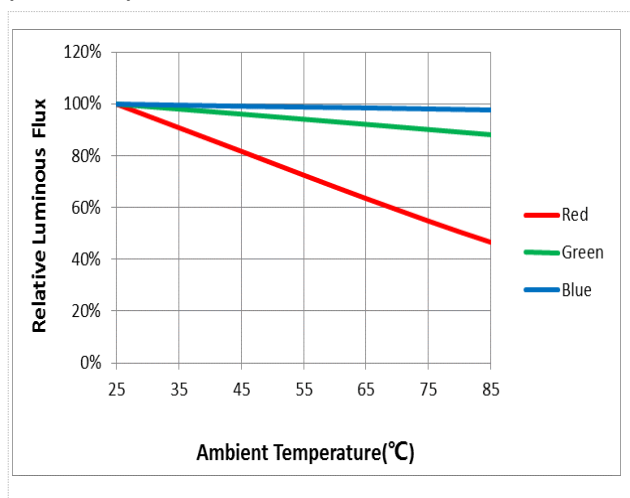

Fig 6. Ambient Temperature vs. Relative Forward Voltage (IF=150mA)

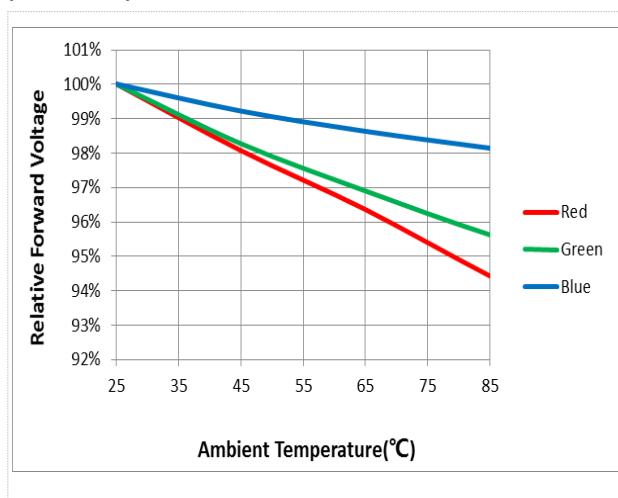
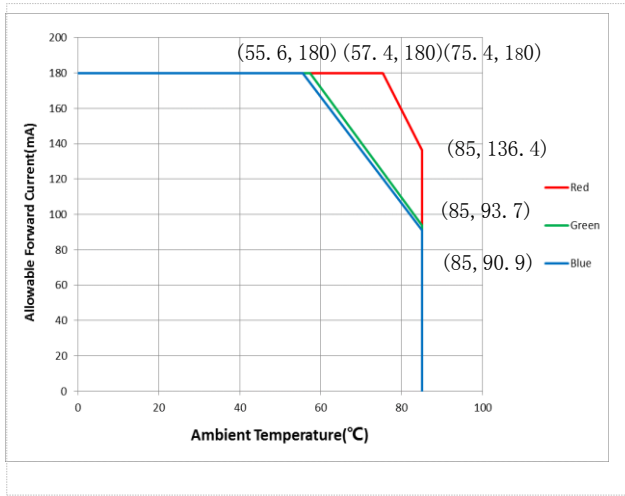
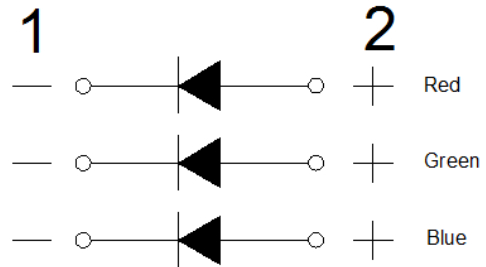
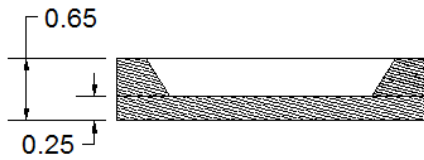
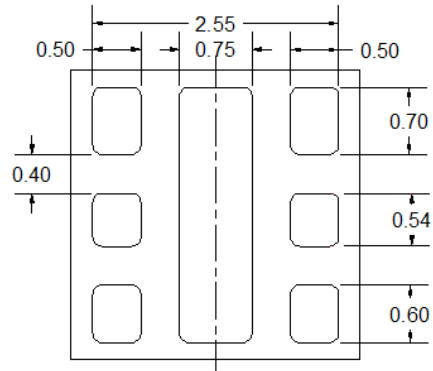
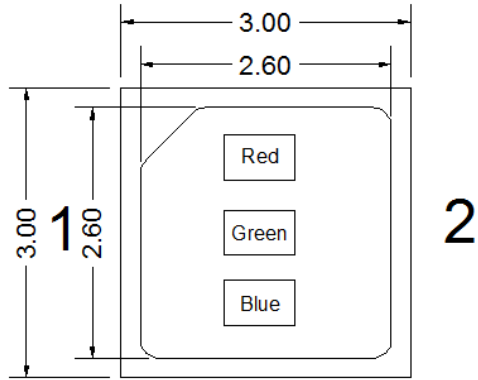

Fig 7. Ambient Temperature vs.Maximum Forward



Package Dimensions



* The tolerance unless mentioned is $\pm 0.2\text{mm}$, unit = mm

Recommended Solder Pad

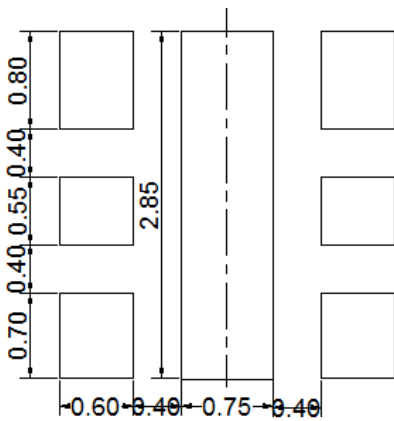

Recommended PCB Solder Pad

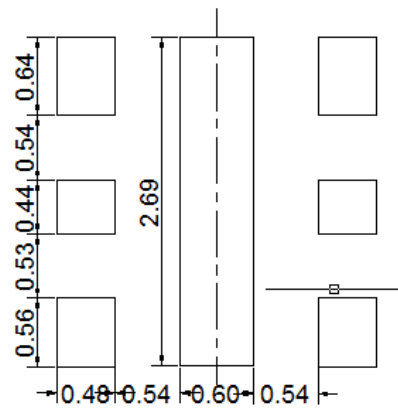

Recommended Stencil Pattern

* The tolerance unless mentioned is $\pm 0.1\text{mm}$, unit = mm

Reflow Soldering Characteristics

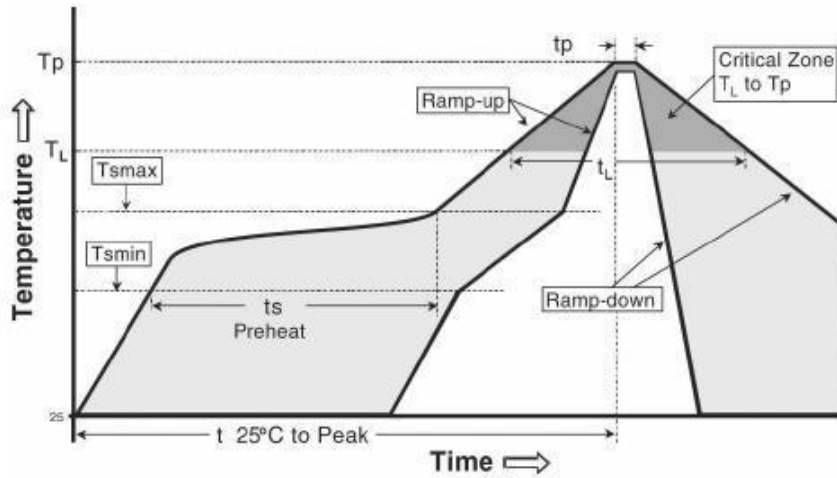

Reflow soldering	
Temperature Min (Tsmmin)	150° C
Temperature Max (Tsmmax)	200° C
Time(ts)from (Tsmmin to Tsmmax)	60-120 seconds.
Ramp-up rate (TL to Tp)	3° C/seconds max.
Liquidous temperature(TL)	217° C
Time(tL) maintained above TL	60-150 seconds
Peak package body temperature(Tp)	260° C max
Time (tp) within 5° C of the specified classification temperature (Tc).	30 seconds max
Ramp-down rate (Tp to TL)	6° C/second max
Time 25 ° C to peak temperature	8 min max

Package Dimensions of Tape

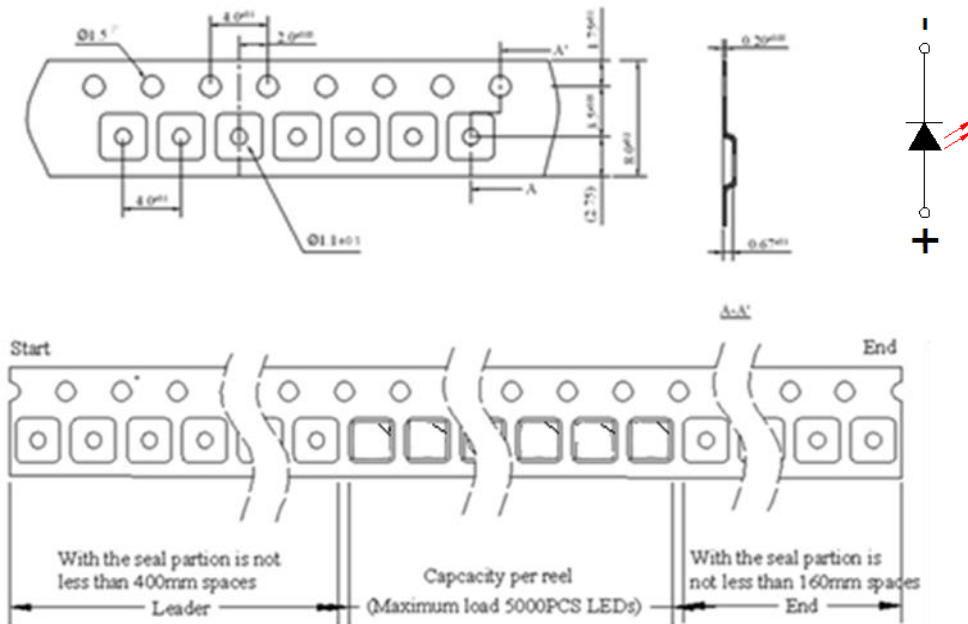

- * Quantity : Max 5000pcs/Reel
- * Cumulative Tolerance : Cumulative Tolerance/10 pitches to be $\pm 0.25\text{mm}$
- * Package : P/N, Manufacturing data Code No. and Quantity to be indicated on a damp proof Package.
- * unit = mm

Package Dimensions of Reel

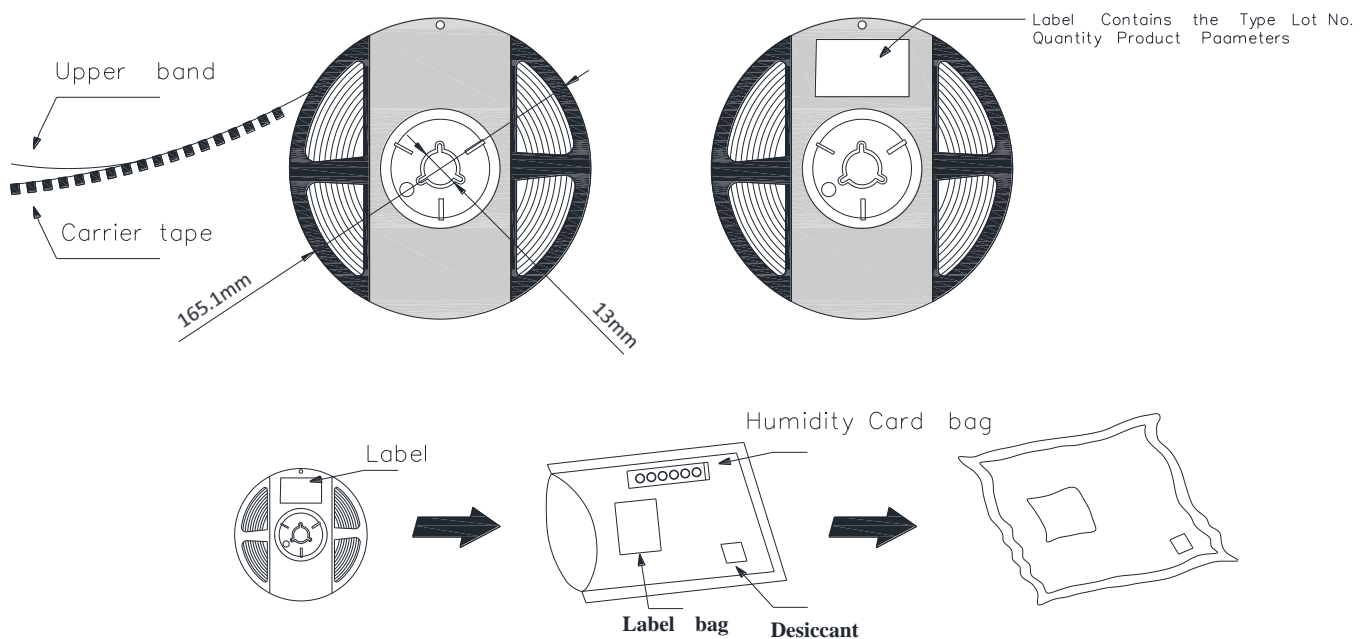

Package Box

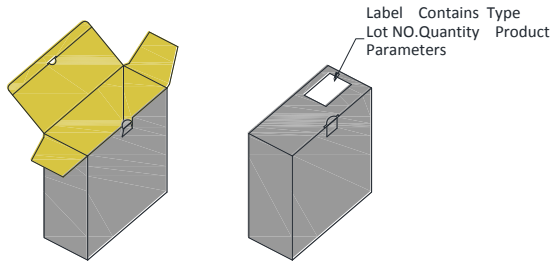

* Capacity 10 reels per box.

Outer Box

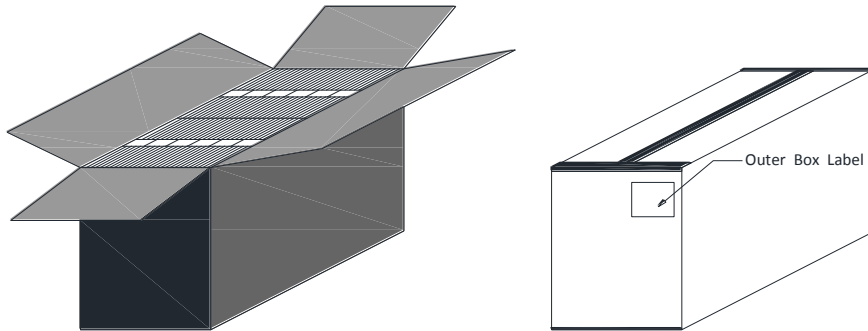

* Capacity 30 or 60 reels per box.

Label

福建天电光电有限公司
FUJIAN LIGHTNING OPTOELECTRONIC CO.,LTD

型号 Type: T3CCW013S-Q3301



项 目	主波长WLD	光通量Φ	电压V
[R]	617.5-622.5[nm]	22-28 [Lm]	2.2-2.4 [V]
[G]	522.5-527.5[nm]	44-51 [Lm]	3.0-3.2 [V]
[B]	455-460 [nm]	7.0-12 [Lm]	3.2-3.4 [V]

测试电流: 150 mA 数量 Qty: 5000 PCS

Lot NO. : AE1810208 -X -8109006



Caution

1. Reflow soldering is recommended not to be done more than two times. In the case of more than 24 hours passed soldering after first, LEDs will be damaged.
2. Repairs should not be done after the LEDs have been soldered. When repair is unavoidable, suitable tools must be used.
3. Die slug is to be soldered.
4. When soldering, do not put stress on the LEDs during heating.
5. After soldering, do not warp the circuit board.

Notes on Lightning EMC Series soldering:

1. Recommend to use reflow machine.
2. Recommend to use heating plate soldering.
3. Manual soldering is not recommended.

Notes on reflow process:

1. To confirm whether the actual temperature curve in the reflow soldering conditions comply with recommended conditions. LEDs are guaranteed for one time reflow.
2. During reflow process do not apply force on LED active area.
3. After reflow process, PCB board should be cooled down before packing or storage.

Precaution for use

Storage

1. Before opening the package: The LED should be kept at 30°C or less and 90%RH or less.
2. After opening the package: The LED's floor life is 168Hrs under 30°C or less and 60%RH or less. If unused LED remain, it should be stored in moisture proof packages JEDEC (MSL 3).
3. If the moisture absorbent material (silica gel) has faded away or the LEDs have exceeded the storage time, baking treatment should be performed using the following conditions:
Baking treatment: 60±5°C for 24 hours.