

SPECIFICATIONS FOR T19 SERIES

White LED

Model: Ceramic 3535

Part No: T19xxx11A-xxxxxx

Features:

- * White,70-CRI, 80-CRI, 90-CRI
- * High luminous flux output
- * High current capability
- * Maximum drive current: 1 A
- * Low thermal resistance: as low as 5 °C/W
- * viewing angle:120±5°
- * Pb-free Reflow Soldering Application
- * The product itself will remain within RoHS compliant version

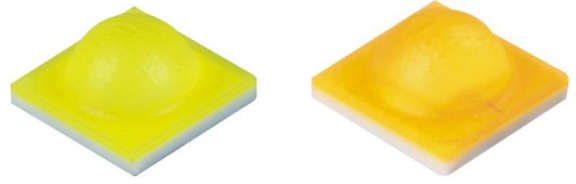

Applications

- * Indoor lighting
- * Outdoor lighting
- * General lighting
- * Architectural lighting
- * Automotive
- * Portable torch
- * Industrial lighting (High/Low bay)

Part Numbering System

T □□ □□ □ □ □ □ - □ □□ □□ □
 X1 X2 X3 X4 X5 X6 X7 X8 X9 X10

Item Number Code	Description	Content
X1	Type code	1S:1010; 1A:1919; 20:2016; 3B:3014; 28:2835 34:3020; 3C:3030; 5C:5050; 7C:7070; 1D:100100; 19: Ceramic 3535; 15: Ceramic 5050; 11: Ceramic 1616.
X2	CCT code	2700K:27; 3000K:30; 4000K:40; 5000K:50; 5700K:57; 6500K:65
X3	Color Rendering	Ra70:7; Ra80:8; Ra90:9
X4	No. of serial chip	1-Z.
X5	No. of parallel chip	1-Z.
X6	Component code	A-Z.
X7	Color Code	M:ANSI; F:ERP; R:85°C ANSI; T:105°C ANSI; B:Backlighting; Q:Others; AT:Tospo
X8	Internal code1	\
X9	Internal code2	\
X10	Spare code	\

Electro Optical Characteristics, IF = 350mA

CCT	Color Rendering	Luminous Flux		
		Ta=25°C		Ta=85°C
	Min.	Typ.	Min.	Typ.
2700K	80	141	130	123
	90	124	114	107
3000K	80	146	139	127
	90	129	114	112
3500K	80	149	139	130
	90	132	114	115
4000K	70	167	148	146
	80	152	139	132
	90	136	122	118
5000K	70	163	148	142
	80	154	139	134
	90	139	122	121
5700K	70	167	148	145
	80	157	139	137
	90	143	122	124
6500K	70	171	148	149
	80	161	139	140
	90	147	122	128

* Tolerance of measurements of the Luminous Flux is $\pm 7\%$.

* Ra measurement tolerance is ± 2 .

* Correlated Color Temperature is derived from the CIE 1931 Chromaticity diagram.

* The lumen table at 85°C is only for reference.

Absolute Maximum Ratings at Ta=25°C

Item	Symbol	Absolute Maximum Rating	Unit
Forward current	I_F	1000	mA
Pulse Forward current	I_{FP}	1500	mA
Power Dissipation	P_D	3400	mW
Reverse Voltage	V_R	5	V
Operating Temperature	T_{opr}	-40~+105	°C
Storage Temperature	T_{stg}	-40~+105	°C
Junction Temperature	T_j	125	°C
Soldering Temperature	T_{sld}	Reflow Soldering: 230°C or 260°C for 10sec	

* I_{FP} condition with Pulse: Width \leq 100 μ s, Duty cycle \leq 1/10.

* LED's properties might be different from suggested values like above and below tables if operation condition will be exceeded our parameter range. Care is to be taken that power dissipation does not exceed the absolute maximum rating of the product.

* All measurements were made under the standardized environment of Lightning LED.

Electrical/Optical Characteristics at Ta=25°C

Item	Symbol	Min	Typ	Max	Unit	Condition
Forward Voltage	V_F	2.6	3.0	3.4	V	$I_F=350$ mA
Reverse Current	I_R	-	-	10	μ A	$V_R=5$ V
View Angle	$2\theta_{1/2}$	-	120	-	°	$I_F=350$ mA
Thermal resistance	($R_{th\ j-sp}$)	-	5	-	°C/W	$I_F=350$ mA
Electrostatic Discharge	ESD	1000	-	-	V	HBM

* Tolerance of measurements of the Forward Voltage is ± 0.1 V.

* $2\theta_{1/2}$ is the off-axis where the luminous intensity is 1/2 of the peak intensity.

* Ra measurement tolerance is ± 2 .

* $R_{th\ j-sp}$ is the thermal resistance from LED junction to solder point on MCPCB with electrical power.

Bin Structure

Luminous Flux Ranks, IF = 350mA, Ta =25°C

CCT	Color Rendering		Luminous Flux		
	Min.	Typ.	Code	Min.	Max.
2700K	80	82	2F	130	139
			2G	139	148
			2H	148	156
			2J	156	164
	90	92	2D	114	122
			2E	122	130
			2G	130	139
3000K	80	82	2G	139	148
			2H	148	156
			2J	156	164
			2K	164	172
	3500K	92	2D	114	122
			2E	122	130
			2F	130	139
4000K	70	72	2H	148	156
			2J	156	164
			2K	164	172
			2L	172	182
			2M	182	200
	80	82	2G	139	148
			2H	148	156
			2J	156	164
			2K	164	172
			2L	172	182
6500K	92	2E	122	130	
		2F	130	139	
		2G	139	148	
		2H	148	156	
		2J	156	164	

* Tolerance of measurements of the Luminous Flux is $\pm 7\%$.

* Ra measurement tolerance is ± 2 .

Forward Voltage Ranks, $I_F = 350\text{mA}$, $T_a = 25^\circ\text{C}$

Code	Min.	Max.	Unit
G3	2.6	2.8	V
H3	2.8	3.0	V
J3	3.0	3.2	V
K3	3.2	3.4	V

* Tolerance of measurements of the Forward Voltage is $\pm 0.1\text{V}$.

CIE Chromaticity Diagram, $I_F = 350\text{mA}$, $T_a = 25^\circ\text{C}$

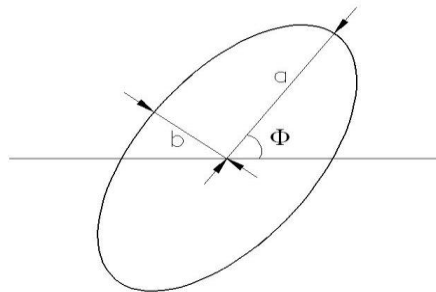

The color ranks have chromaticity ranges within 5-step or 7-steps MacAdam ellipse

Color Code	Center		Radius		Angle(deg)
	x	y	a	b	Φ
27M5	0.4582	0.4099	0.002700	0.001400	53.42
30M5	0.4342	0.4028	0.002780	0.001360	53.13
35M5	0.4080	0.3916	0.003090	0.001380	54.00
40M5	0.3825	0.3798	0.003130	0.001340	53.43
50M5	0.3451	0.3554	0.002740	0.001180	59.37
57M7	0.3290	0.3417	0.002235	0.001100	58.35
65M7	0.3130	0.3290	0.002230	0.000950	58.34

* Energy Star binning applied to all 2600~7000K.

* Tolerance of measurements of the chromaticity Coordinate is ± 0.005 .

Fig 1. Color Spectrum, Ta = 25°C

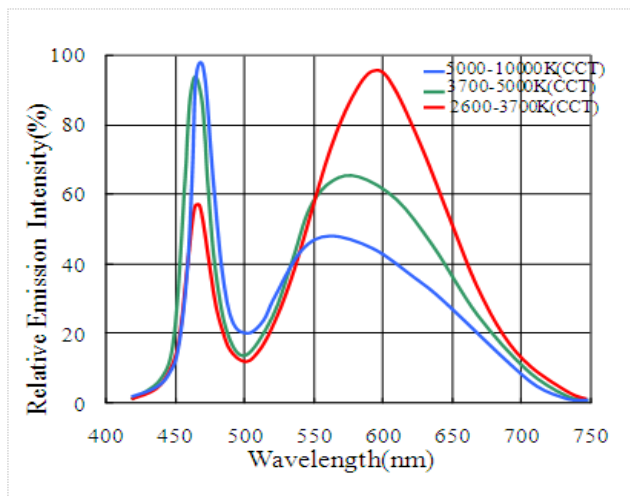

Fig 2. Viewing Angle Distribution, Ta = 25°C

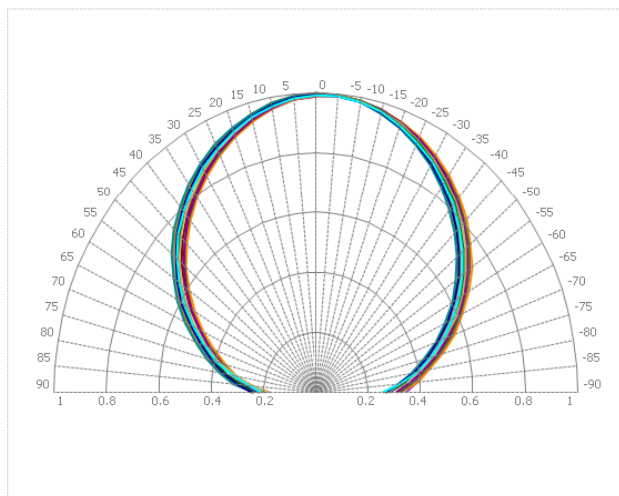

Fig 3. Forward Current vs. Relative Intensity, Ta = 25°C

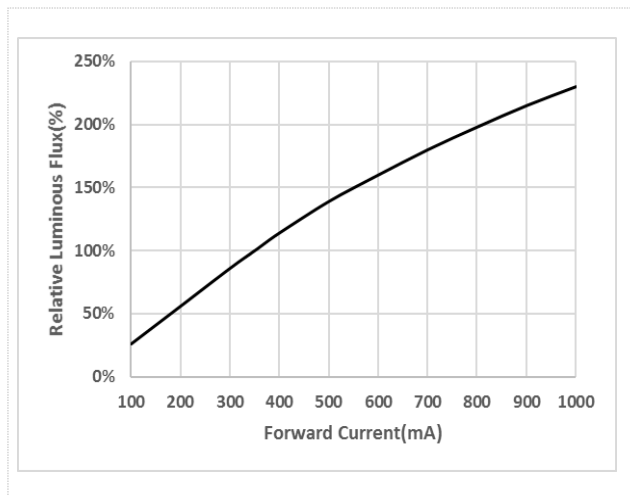

Fig 4. Forward Current vs. Forward Voltage, Ta = 25°C

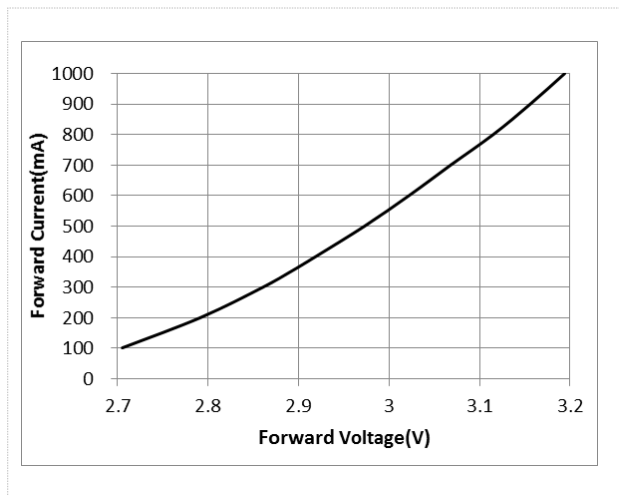

Fig 5. Ambient Temperature vs. Relative Luminous flux (IF=350mA)

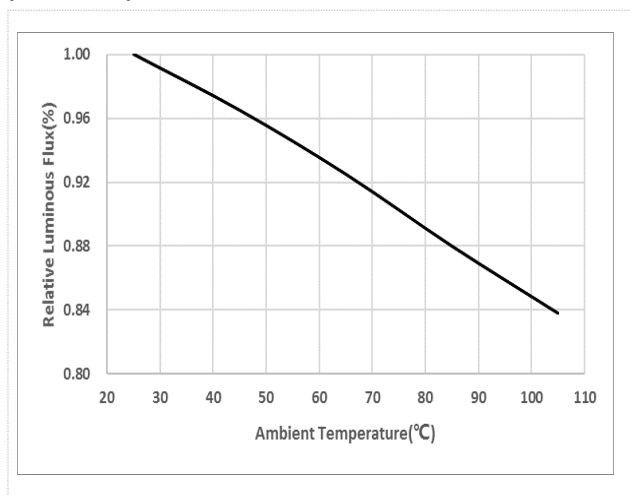

Fig 6. Ambient Temperature vs. Relative Forward Voltage (IF=350mA)

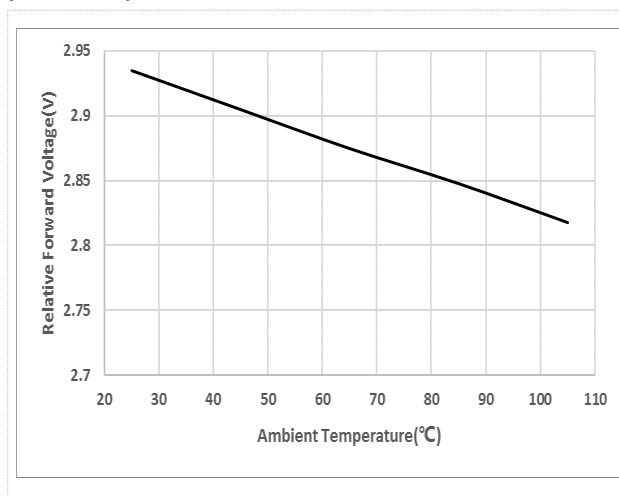

Fig 7. Ambient Temperature vs. CIE(x,y)
(IF=350mA)

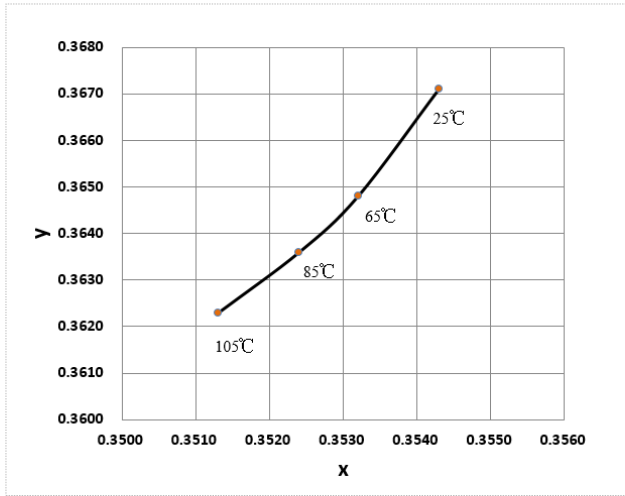
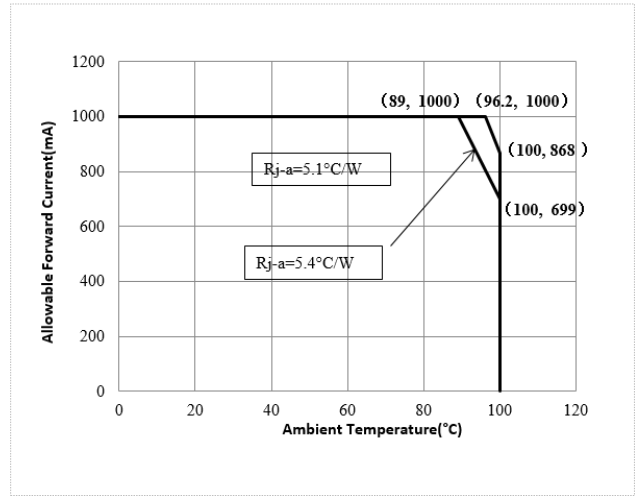
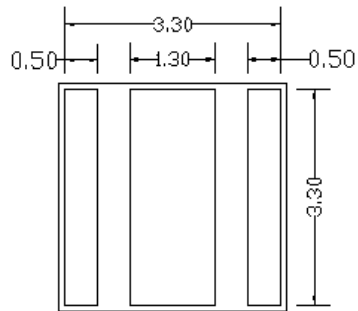
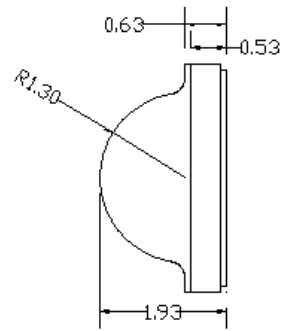
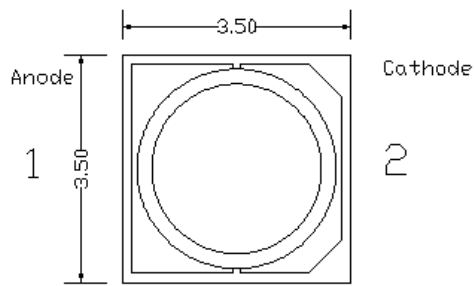

Fig8 . Ambient Temperature vs. Maximum Forward Current



Package Dimensions



Electrically neutral
thermal pad

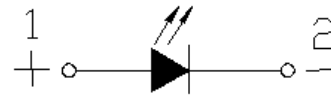

Recommended Solder Pad

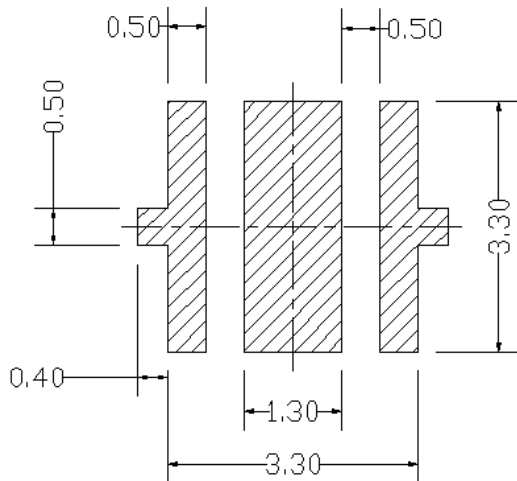

Recommended PCB Solder Pad

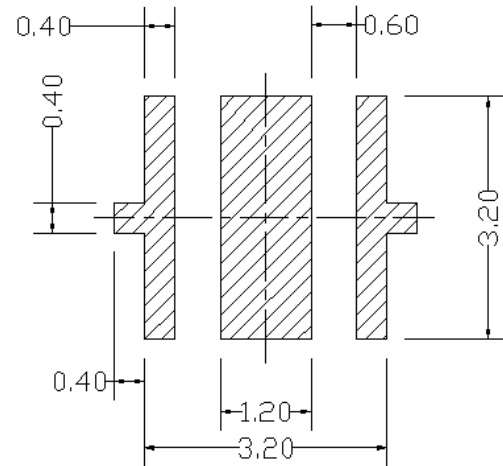

Recommended Stencil Pattern

Reflow Soldering Characteristics

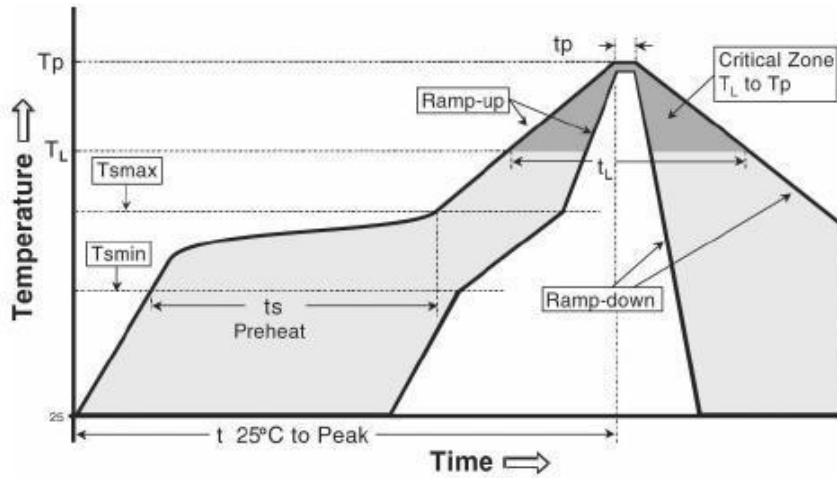

Reflow soldering	
Temperature Min (Tsmmin)	150° C
Temperature Max (Tsmmax)	200° C
Time(ts)from (Tsmmin to Tsmmax)	60-120 seconds.
Ramp-up rate (TL to Tp)	3° C/seconds max.
Liquidous temperature(TL)	217° C
Time(tL) maintained above TL	60-150 seconds
Peak package body temperature(Tp)	260° C max
Time (tp) within 5° C of the specified classification temperature (Tc).	30 seconds max
Ramp-down rate (Tp to TL)	6° C/second max
Time 25 ° C to peak temperature	8 min max

Package Dimensions of Tape

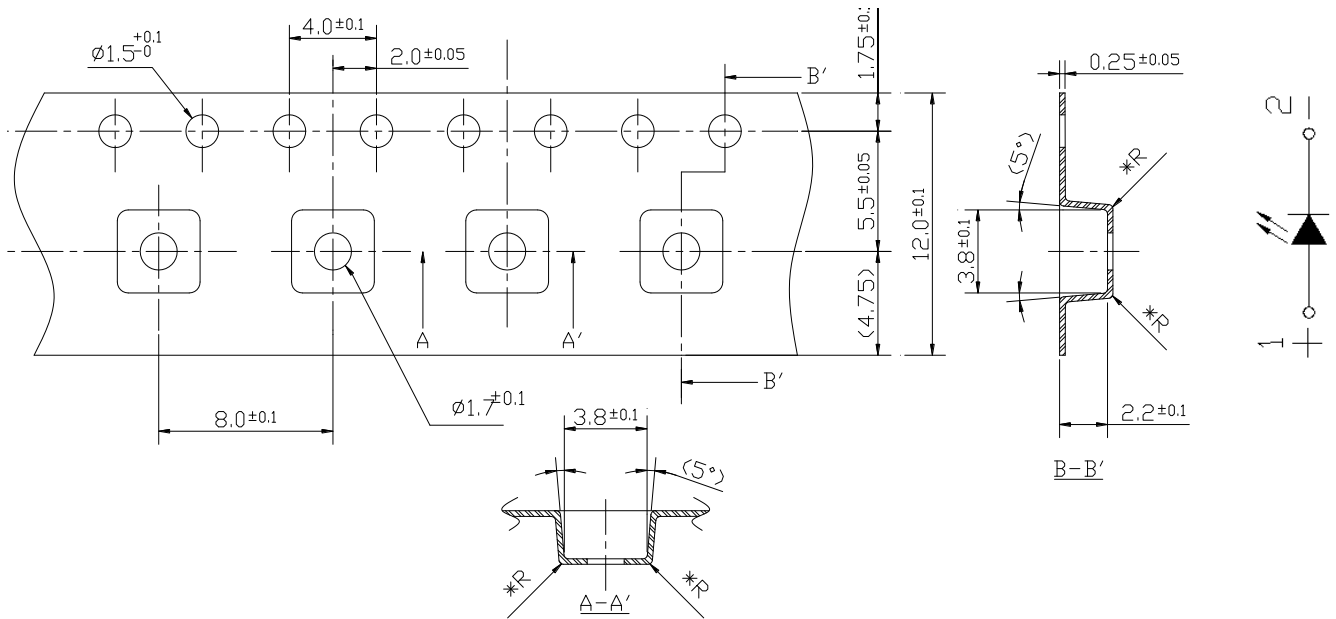

- * Quantity : Max 1000pcs/Reel
- * Cumulative Tolerance : Cumulative Tolerance/10 pitches to be $\pm 0.25\text{mm}$
- * Package : P/N, Manufacturing data Code No. and Quantity to be indicated on a damp proof Package.
- * unit = mm

Package Dimensions of Reel

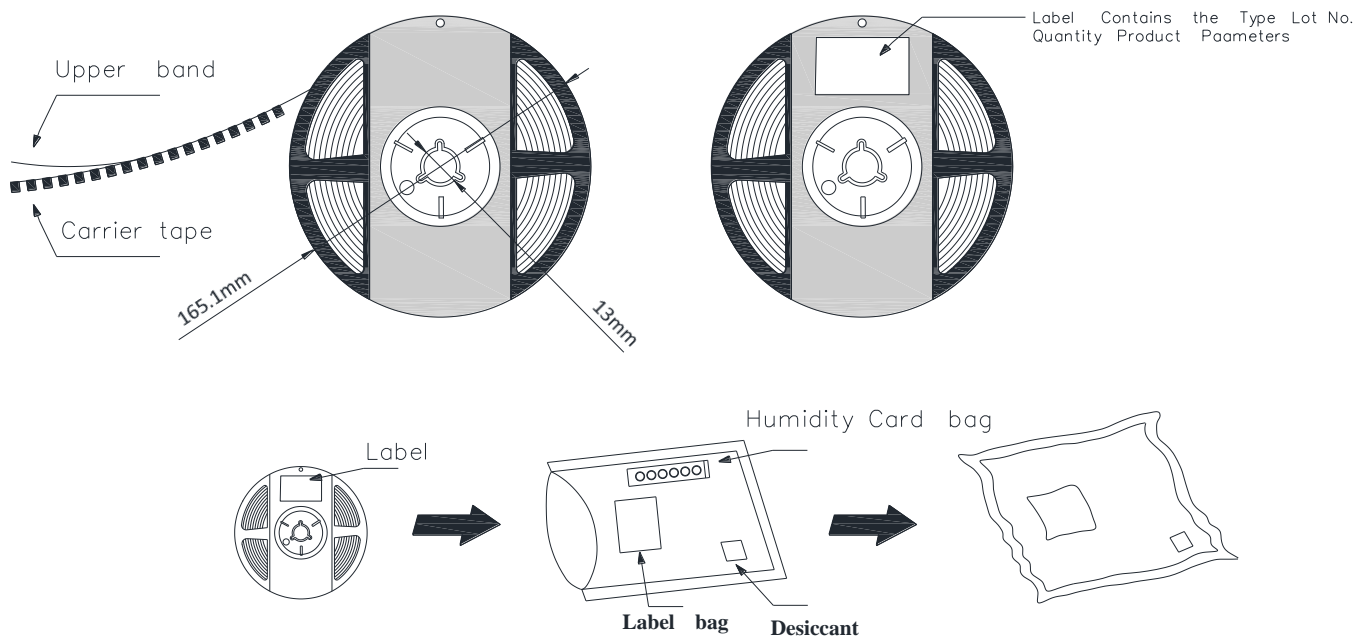

Package Box

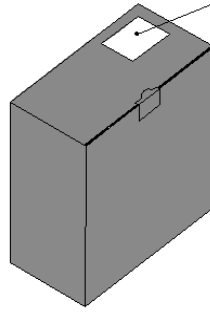
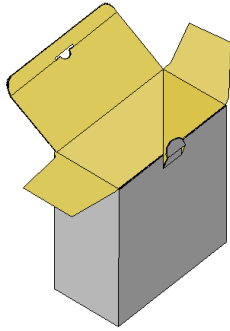

Label: Contains Type,
Lot NO, Quantity, Product
Parameters.

* Capacity 4 or 8 reels per box.

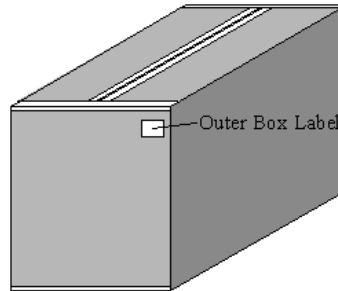
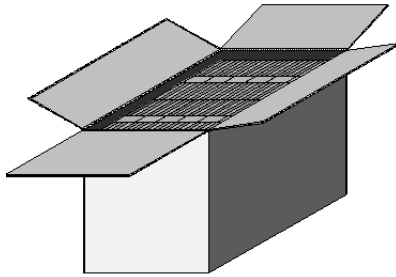

* Capacity 48 or 64 reels per box.

Label

福建天电光电有限公司 FUJIAN LIGHTNING OPTOELECTRONIC CO.LTD	
型号Type: T*****_*****	
	
光通量Φ@ *** mA: *** - *** [LM]	
色区Color Bin@*** mA: ****	
电压Vf@ *** mA: ** - ** [V]	
显指Ra@*** mA: ** (MIN)	
Lot No.: A*****_ *_ *****	
Bin Code: ****	数量QTY: ***** PCS



Caution

1. Reflow soldering is recommended not to be done more than two times. In the case of more than 24 hours passed soldering after first, LEDs will be damaged.
2. Repairs should not be done after the LEDs have been soldered. When repair is unavoidable, suitable tools must be used.
3. Die slug is to be soldered.
4. When soldering, do not put stress on the LEDs during heating.
5. After soldering, do not warp the circuit board.

Notes on Lightning Ceramic Series soldering:

1. Recommend to use reflow machine.
2. Recommend to use heating plate soldering.
3. Manual soldering is not recommended.

Notes on reflow process:

1. To confirm whether the actual temperature curve in the reflow soldering conditions comply with recommended conditions. LEDs are guaranteed for one time reflow.
2. During reflow process do not apply force on LED active area.
3. After reflow process, PCB board should be cooled down before packing or storage.

Precaution for use

Storage

1. Before opening the package: The LED should be kept at 30°C or less and 90%RH or less.
2. After opening the package: The LED's floor life is 168Hrs under 30°C or less and 60%RH or less. If unused LED remain, it should be stored in moisture proof packages JEDEC (MSL 3).
3. If the moisture absorbent material (silica gel) has faded away or the LEDs have exceeded the storage time, baking treatment should be performed using the following conditions:
Baking treatment: 60±5°C for 24 hours.