

- . One of the best Lm/W, Lm/\$ in High-Power LED (高光效、高性价比)
- . High-Power EMC packaging LED – 1A1A 20W Series (LED-1A1A 20W系列)

T1D\*\*\*C3R-\*\*\*\*\* (Cool, Neutral, Warm)

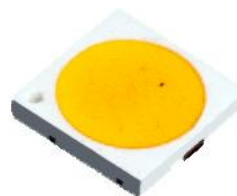

## Product Brief (产品简介)

### Features and Benefits (特性优点)

- . Thermally Enhanced EMC Package Design (高耐热EMC封装)
- . High Power, up to 24W (高功率, 最大使用功率22 w)
- . Max. Driving Current 600mA (最大操作电流600mA)
- . High Color Quality with CRI Min. 90 (显指Ra≥90)
- . Pb-free Reflow Soldering Application (适用无铅回流焊)

### Key Applications (应用)

- . Spot lighting (射灯)
- . Retrofits(replacement) (传统照明替换)
- . General lighting (普通照明)

**Table 1. Product Selection Table (产品目录Ts=85℃)**

Model No. 型号	Color 颜色	Min. 最小值	CCT 色温	
			Typ. 典型值	Max. 最大值
T1D50*C3R-*****	Neutral White (正白)	4745K	5028K	5311K
T1D40*C3R-*****	Neutral White (正白)	3710K	3985K	4260K
T1D30*C3R-*****	Warm White (暖白)	2870K	3045K	3220K
T1D27*C3R-*****	Warm White (暖白)	2580K	2725K	2870K

## Performance Characteristics (特性参数)

Table 2. Electro Optical Characteristics (光电特性), IF = 540mA, Ta = 25 °C, RH60%

Color Temperature 色温	Color Rendering 显指	Luminous Flux (IF=540mA) 光通量	
	Min 最小值	Typ 典型值	Min 最小值
27R5	90	1800	1700
30R5	90	1900	1800
40R5	90	2100	2000
50R5	90	2100	2000

- Tolerance of measurements of the Luminous Flux is  $\pm 7\%$  (LM测试误差 $\pm 7\%$ )
- Ra measurement tolerance is  $\pm 2$  (Ra测试误差 $\pm 2$ )
- Correlated Color Temperature is derived from the CIE 1931 Chromaticity diagram (CCT参考CIE 1931色度图)
- The lumen table is only for reference (LM参数供参考)
- Ta = 25 °C, RH60% (温度: 25 °C, 湿度: 60%)

## Performance Characteristics (特性参数)

Table 3. Electro Optical Characteristics (光电特性),  $I_F = 540\text{mA}$ ,  $T_a = 25^\circ\text{C}$ , RH60%

Item 参数	Symbol 符号	Value 数值			Unit 单位	Test Condition 测试条件
		Min 最小值	Typ 典型值	Max 最大值		
Forward Voltage 正向电压	VF	36	37.5	39	V	$I_F=540\text{mA}$
Reverse Current 反向电流	IR	-	-	10	$\mu\text{A}$	$V_R=5\text{V}$
View Angle 发光角度	2 $\theta$ 1/2	-	120	-	°	$I_F=540\text{mA}$
Thermal Resistance 热阻	( $R_{th\ j-sp}$ )	-	1	-	$^\circ\text{C}/\text{W}$	$I_F=540\text{mA}$
Electrostatic Discharge 防静电	ESD	5000	-	-	V	-

- Tolerance : VF :  $\pm 2\%$  (VF测试误差 $\pm 2\%$ )
- 2 $\theta$ 1/2 is the off-axis where the luminous intensity is 1/2 of the peak intensity (2 $\theta$ 1/2即为发光强度为峰值强度1/2的角度)
- Thermal resistance :  $R_{thJS}$  (Junction / solder) 热阻值 (结点至焊点)
- $T_a = 25^\circ\text{C}$ , RH60% (温度:  $25^\circ\text{C}$ , 湿度: 60%)

## Performance Characteristics (特性参数)

Table 4. Absolute Maximum Ratings (最大额定参数),  $T_a = 25^\circ\text{C}$ , RH60%

Item 参数名称	Symbol 符号	Absolute Maximum Ratings 最大额定参数	Unit 单位
Forward Current 正向电流	IF	600	mA
Pulse Forward Current 正向脉冲电流	IFP	860	mA
Power Dissipation 功率损耗	PD	24.0	mW
Reverse Voltage 反向电压	VR	5	V
Operating Temperature 操作温度	Topr	-40~+105	°C
Storage Temperature 储存温度	Tstg	-40~+100	°C
Junction Temperature 结温	Tj	125	°C
Soldering Temperature 回流温度	Tsld	230°C or 260°C for 10sec	

- IFP condition with Pulse: Width $\leq$ 100 $\mu$ s Duty cycle $\leq$ 1/10
- LED's properties might be different from suggested values like above and below tables if operation condition will be exceeded our parameter range. Care is to be taken that power dissipation does not exceed the absolute maximum rating of the product
- 正向脉冲电流条件:脉冲宽度 $\leq$ 100 $\mu$ s, 占空比 $\leq$ 1/10
- 操作条件若超出最大额定参数, 可能会对LED造成不可预期伤害

## Relative Spectral Distribution (光谱分布)

Fig 1. Color Spectrum (光谱图),  $T_a = 25^\circ\text{C}$ , RH60%

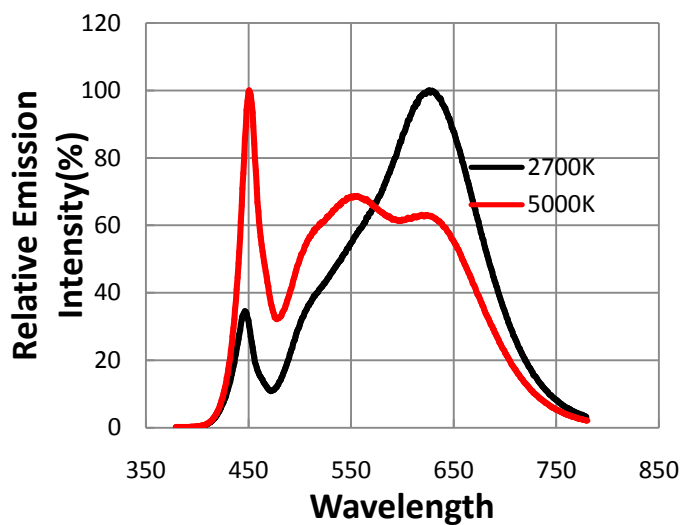
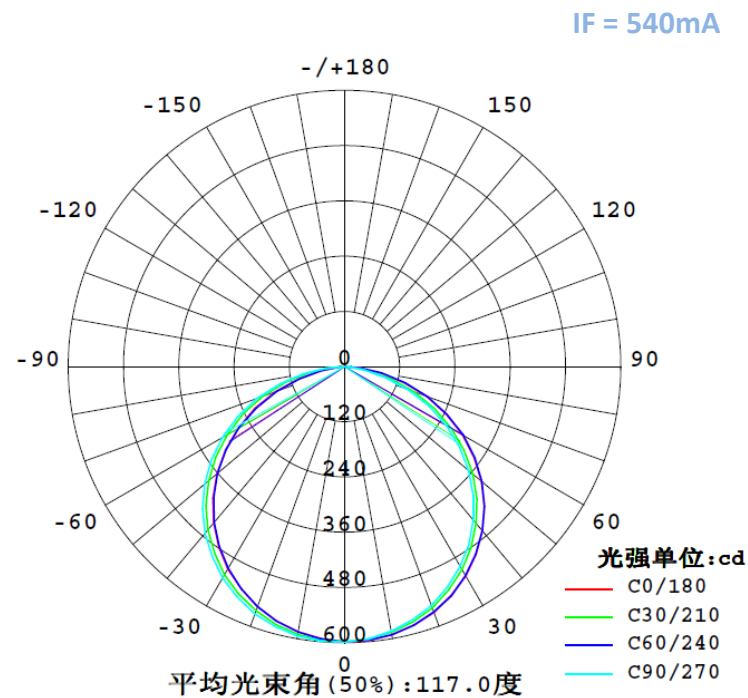

Fig 2. Viewing Angle Distribution (发光角度),  $T_a = 25^\circ\text{C}$ , RH60%



## Forward Current Characteristics (IV特性曲线)

Fig 3. IF--- Relative Luminous flux , Ta = 25°C  
(亮度与电流关系, 温度=25°C)

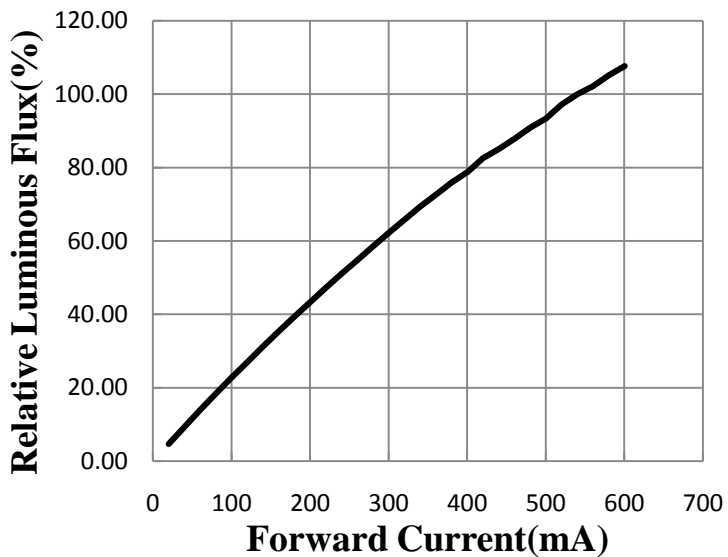
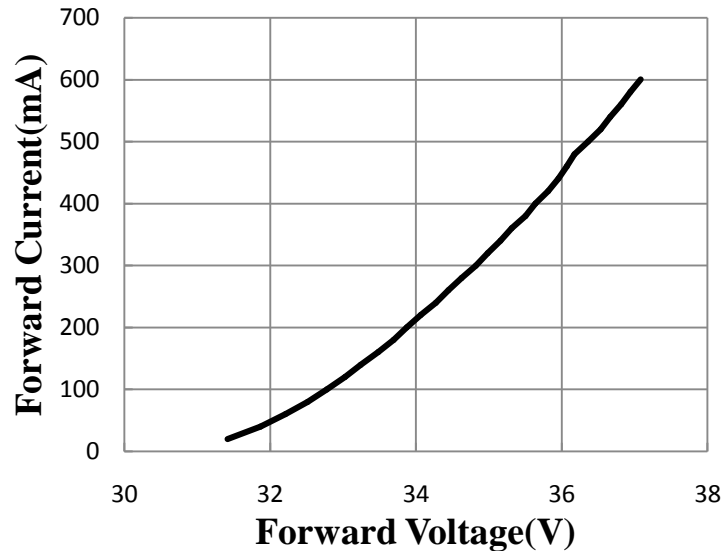
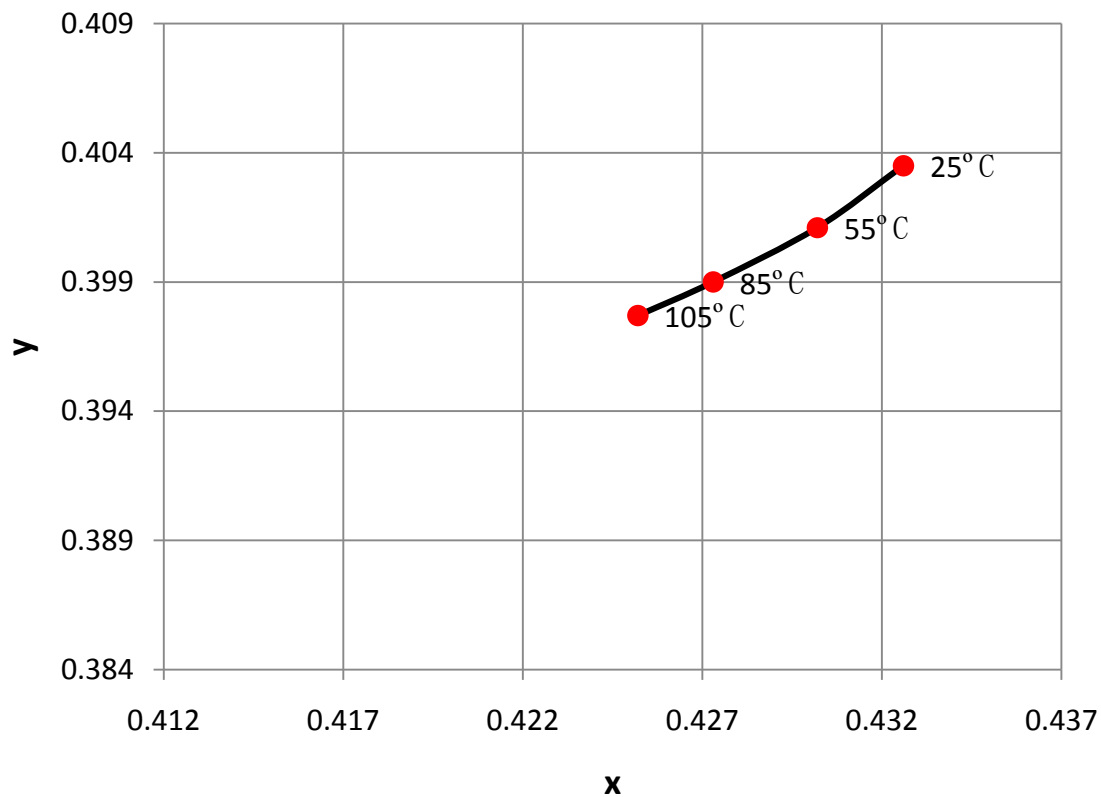

Fig 4. Forward Voltage vs. Forward Current , Ta = 25°C  
(电压与电流关系, 温度=25°C)



## Ta vs. CIE x, y Shift (温度漂移曲线)

Fig 5. Ta vs. CIE x, y Shift (温度与CIE x, y 关系)



## Iv & Vf VS Temperature Characteristics (亮度与电压 vs 温度)

Fig 6. Ta—Relative Luminous flux (温度与亮度关系)

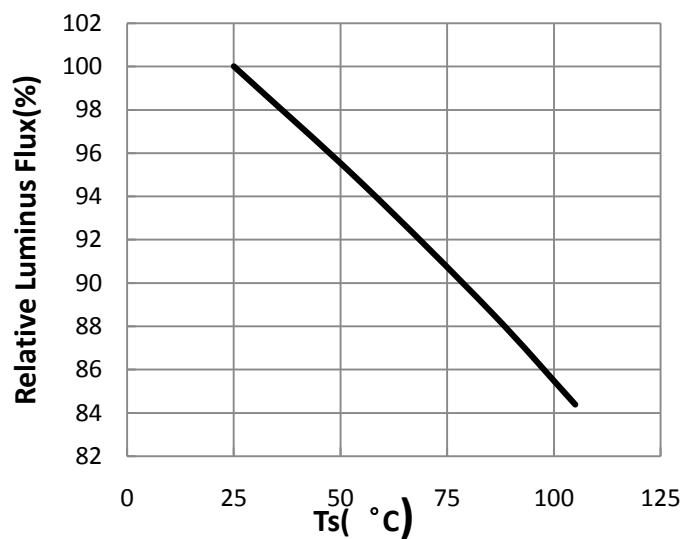
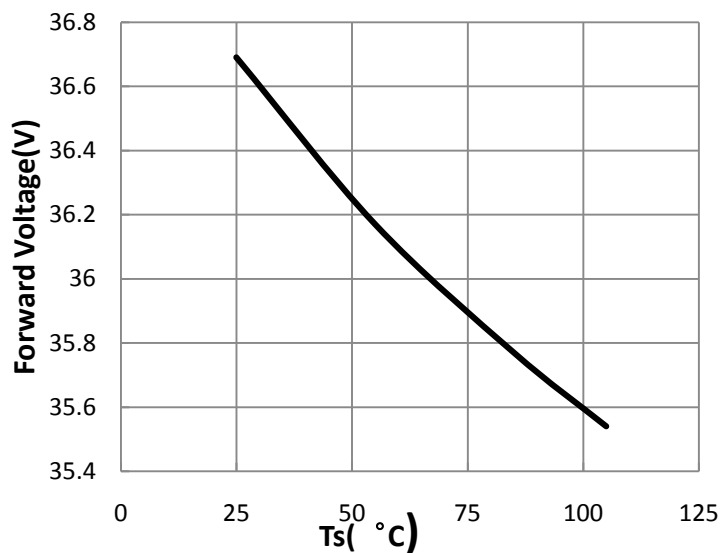

Fig 7. Ta—Forward Voltage (温度与电压关系)





## Ambient Temperature Characteristics (电流温度关系特性)

Fig 8, Maximum Forward Current vs. Ambient Temperature (最大正向电流vs环境温度)

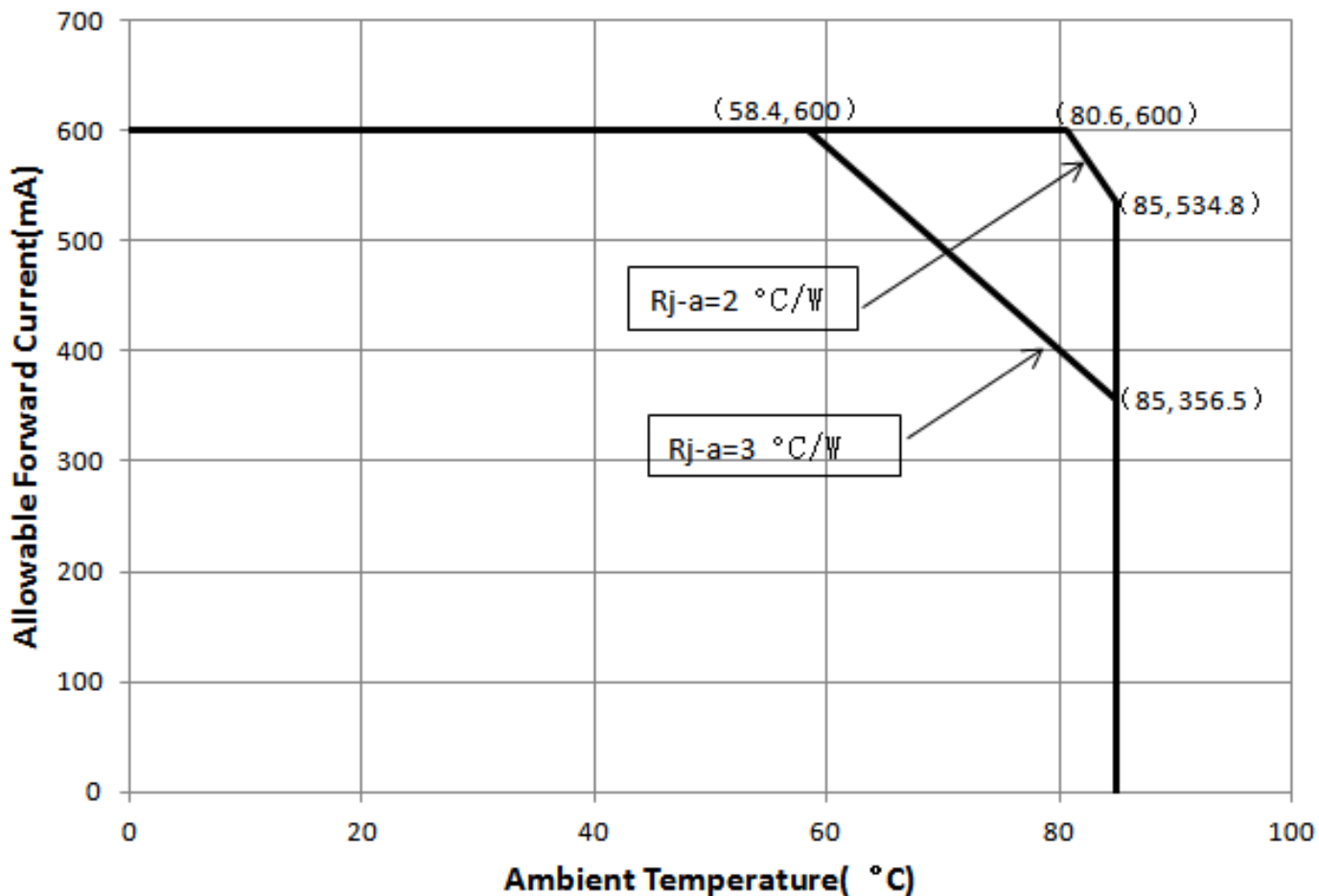

## Color Bin Structure (分色方式)

Fig 9, CIE Chromaticity Diagram (CIE色区图),  $I_F = 540\text{mA}$ ,  $T_a = 25^\circ\text{C}$

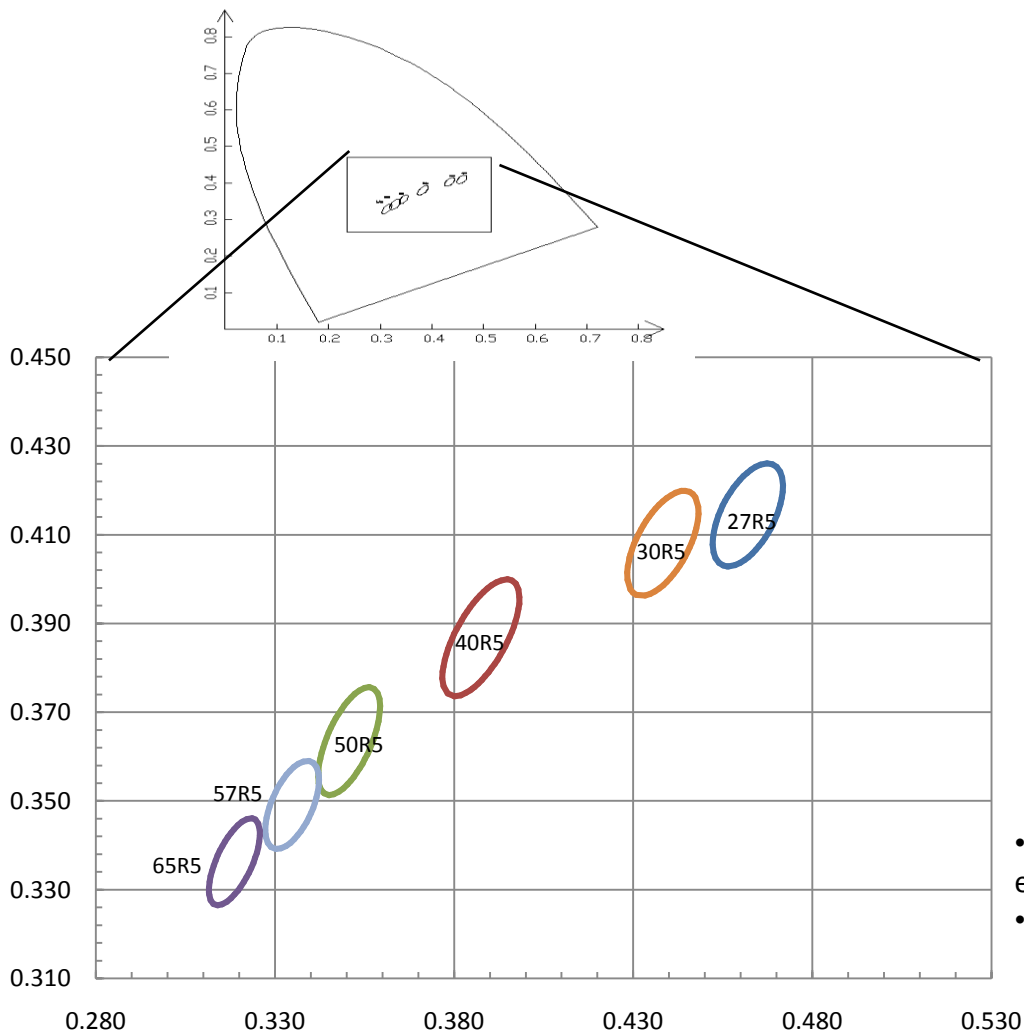

- All measurements were made under the standardized environment of Lightning LED.
- 所有测量都在天电标准环境下进行。

## Color Bin Structure (分色方式)

Table 5. Bin Code description (分光色区图),  $I_F = 540\text{mA}$ ,  $T_a = 25^\circ\text{C}$ ,  $\text{RH}60\%$

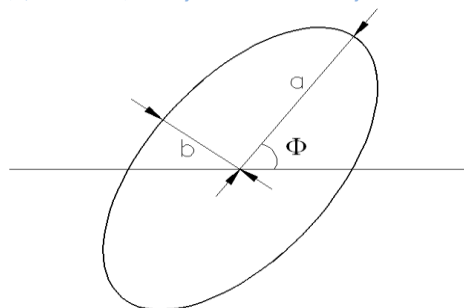

Color Code 色区代码	Center 色区中心点		Radius 半径		Angle 角度
	x	y	a	b	$\Phi$
27R5	0.4620	0.4145	0.002700	0.001400	53.42
30R5	0.4383	0.4081	0.00278	0.00136	53.13
40R5	0.3875	0.3868	0.003130	0.001340	53.43
50R5	0.3507	0.3635	0.002740	0.001180	59.37
57R5	0.3348	0.3491	0.002235	0.001100	58.35
65R5	0.3187	0.3363	0.002230	0.000950	58.34

- Energy Star binning applied to all 2600~7000K (所有2600~7000K分色方式参照能源之星定义)
- Measurement Uncertainty of the Color Coordinates:  $\pm 0.007$  (色坐标的测试误差:  $\pm 0.007$ )
- $T_a = 25^\circ\text{C}$ ,  $\text{RH}60\%$  (温度:  $25^\circ\text{C}$ , 湿度:  $60\%$ ).

## Mechanical Dimensions (产品尺寸)

### Mechanical Dimensions (产品尺寸)

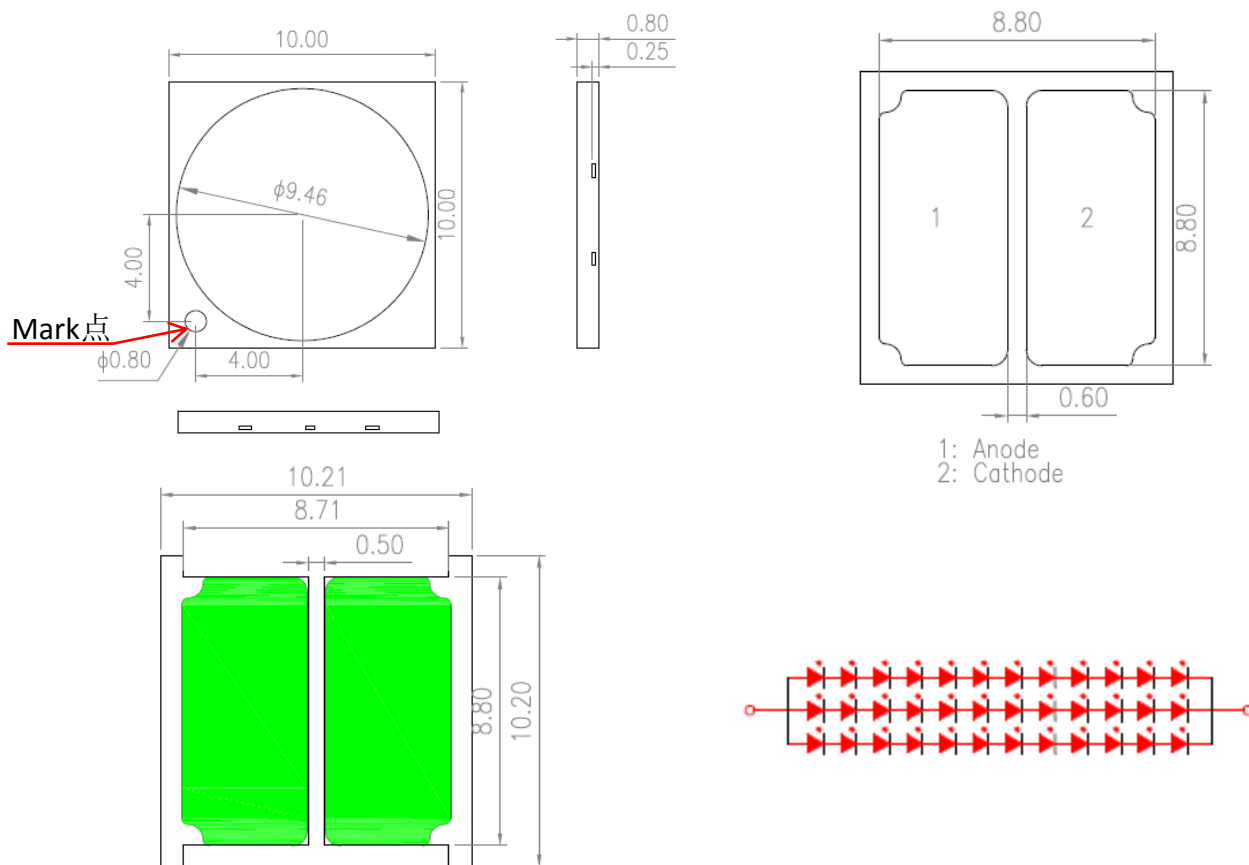

- All dimensions are in millimeters (图中所有尺寸均以毫米为单位)
- Scale : 1:1 (比例: 1:1)
- Undefined tolerance is  $\pm 0.2\text{mm}$  (尺寸公差:  $\pm 0.2$ 毫米)
- Mark for the anode (Mark 是正极)

## Recommended Solder Pad (焊盘设计)

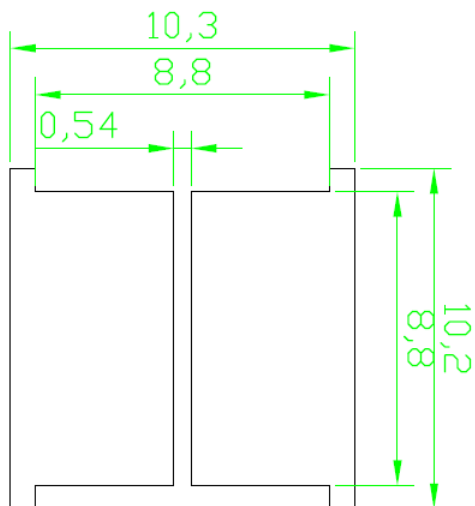

**Recommended solder pad**  
建议焊盘

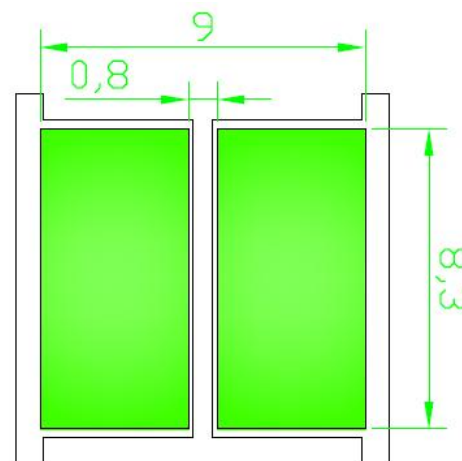

**Recommended stencil opening**  
建议钢网

- All dimensions are in millimeters.
- Scale : 1:1
- This drawing without tolerances are for reference only
- Undefined tolerance:  $\pm 0.10\text{mm}$

- 图中所有尺寸均以毫米为单位
- 比例: 1:1
- 图纸仅供参考
- 若无特殊标注, 图中公差尺寸为 $\pm 0.10\text{mm}$

## Packaging Information (包装信息)

### Reel Packaging (卷带包装)

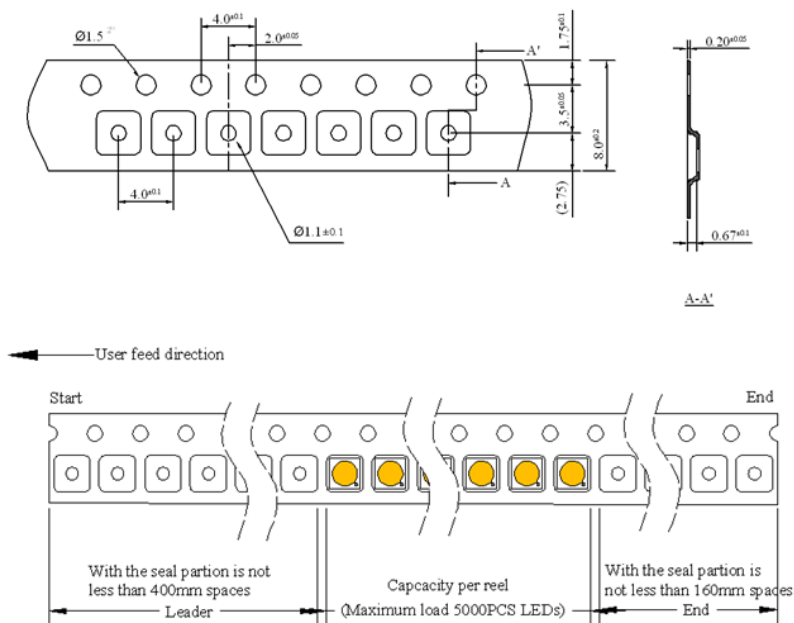

- Quantity : Max 2000pcs/Reel
- Cumulative Tolerance : Cumulative Tolerance/10 pitches to be  $\pm 0.2$ mm
- Adhesion Strength of Cover Tape Adhesion strength to be 0.1-0.7N when the cover tape is turned off from the carrier tape at the angle of  $10^\circ$  to the carrier tape
- Package : P/N, Manufacturing data Code No. and Quantity to be indicated on a damp proof Package
- 数量: 最多2000pcs/卷
- 10 pitches累积公差 :  $\pm 0.2$ mm
- 上带剥离强度为0.1-0.8N
- 包装信息包含料号, 生产日期及数量等

## Packaging Information (包装信息)

### Reel Packaging (卷带包装)

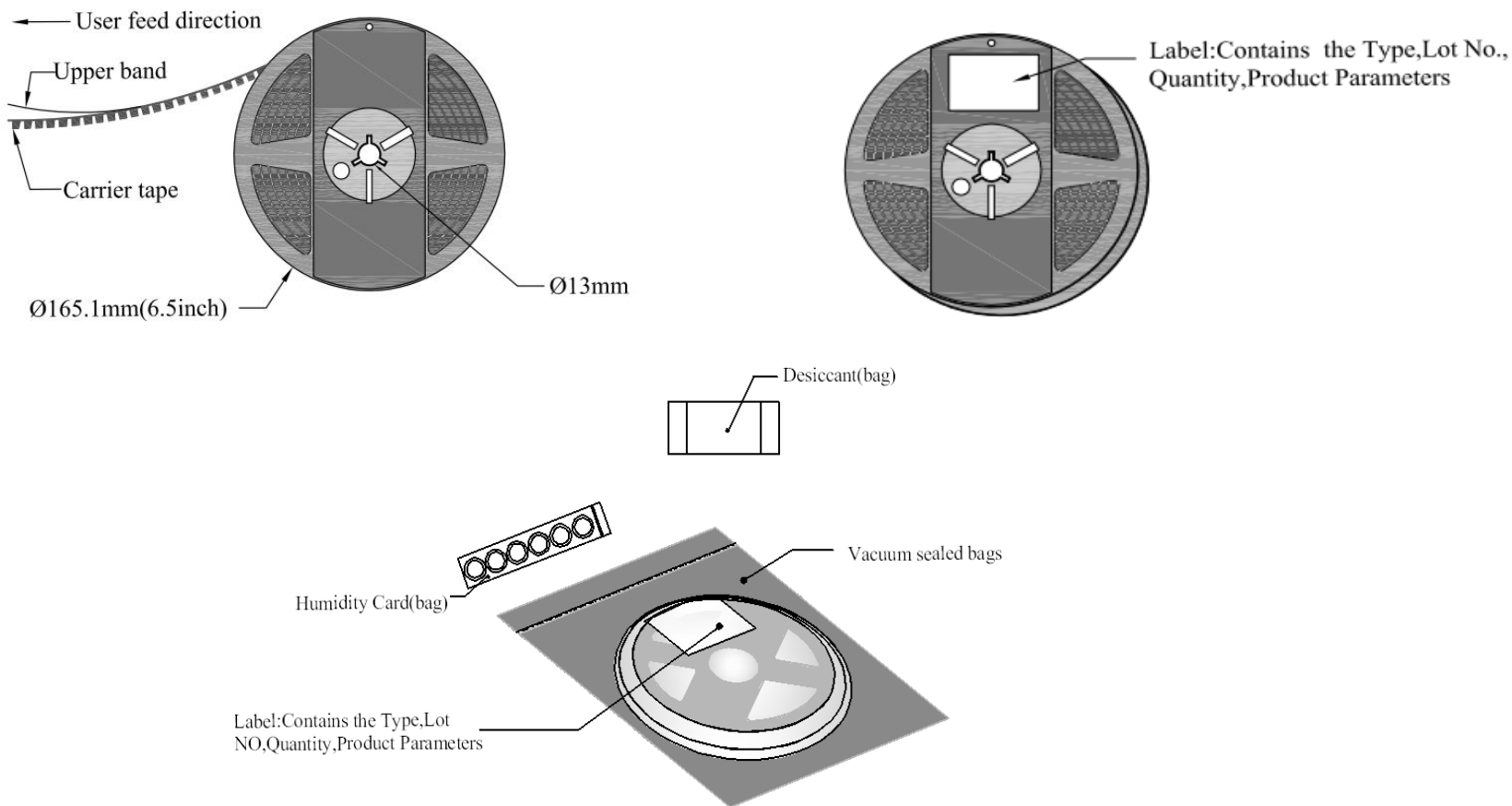

## Packaging Information (包装信息)

### Inner Box (内箱)

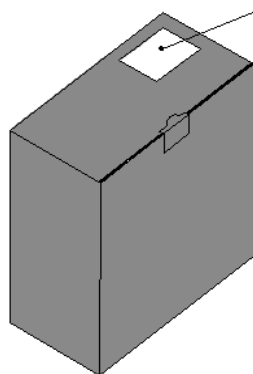
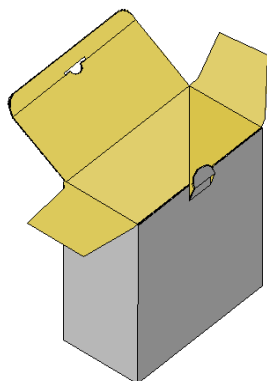

Label: Contains Type,  
Lot NO, Quantity, Product  
Parameters.

\* Capacity 5 or 10 reels per box (内箱容量: 5或10卷)

### Outer Box (外箱)

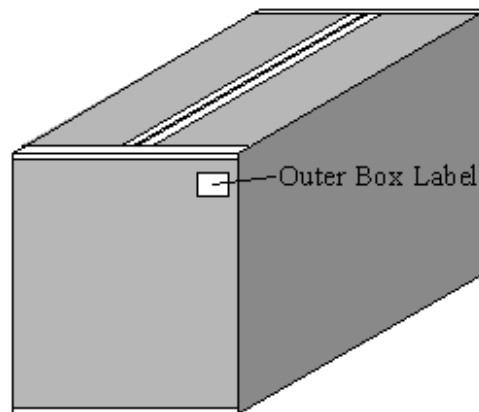
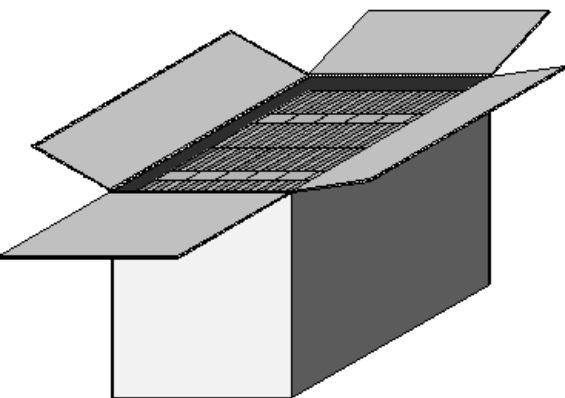

Outer Box Label

\* Capacity 30 or 60 reels per box (外箱容量: 30或60卷)

### Label (标签)

深圳市天电光电科技有限公司			
LIGHTNING OPTOELECTRONIC TECHNOLOGY(SZ)CO.,LTD			
产品型号Type:	T*****C-***AA		
项目Item:	Min	Max	Unit
电压 Vf@**mA:	**	**	V
光通量 Φ@**mA:	**	**	Lm
色区Color Bin@**mA:	**(*****)		
显指 Ra@**mA:	**(MIN)		
Lot No. :XXXXXX-XX	数量QTY: ****PCS		



## Product Nomenclature (命名原则)

Table 8. Part Numbering System(命名原则) : T □□ □□ □ □ □ □ – □ □□ □□  
X1 X2 X3 X4 X5 X6 X7 X8 X9

Item Number Code 序号代码	Description 描述	Content 内容
X1	Type code 产品代码	34:3020; 3A:K285; 3B:3014; 3C:3030; 5A:5050N; 7C:7070; 1D:100100; 32: 3528; 19: Ceramic 3535; 15: Ceramic 5050; 12: Ceramic 9292; 20: 2016.
X2	CCT code 色温代码	2725±145K: 27 3045±175K: 30 3985±275K: 40 5028±283K: 50 5665±355K: 57 6530±510K: 65
X3	Color Rendering 显指	Ra70: 7; Ra80: 8; Ra90: 9
X4	No. of serial chip 晶片串联数量	1-Z.
X5	No. of parallel chip 晶片并联数量	1-Z.
X6	Component code 补充码	A-Z
X7	Internal code1 内部码1	\
X8	Internal code2 内部码2	\
X9	Internal code3 内部码3	\

## Reflow Soldering Characteristics (建议回流焊方式)

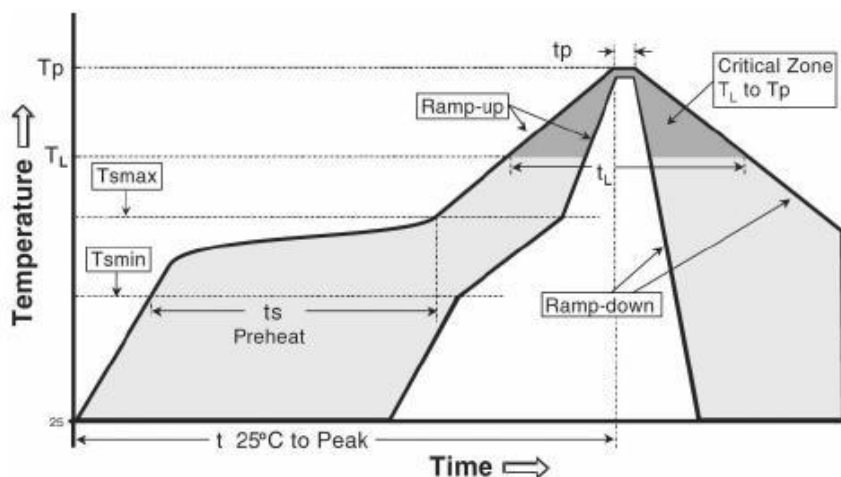

Reflow soldering	
Temperature Min (T <sub>smin</sub> ) Temperature Max (T <sub>smax</sub> ) Time(t <sub>s</sub> )from ( T <sub>smin</sub> to T <sub>smax</sub> )	150 °C 200 °C 60-120 seconds.
Ramp-up rate (T <sub>L</sub> to T <sub>p</sub> )	3 °C/seconds max.
Liquidous temperature(T <sub>L</sub> ) Time(t <sub>L</sub> ) maintained above T <sub>L</sub>	217 °C 60-150 seconds
Peak package body temperature( T <sub>p</sub> )	260 °C max
Time (t <sub>p</sub> ) within 5 °C of the specified classification temperature(T <sub>c</sub> ).	30 seconds max
Ramp-down rate (T <sub>p</sub> to T <sub>L</sub> )	6 °C/second max
Time 25 °C to peak temperature	8 min max

## Pre-caution for use (注意事项)

---

### Caution

1. Reflow soldering is recommended not to be done more than two times. In the case of more than 24 hours passed soldering after first, LEDs will be damaged.
2. Repairs should not be done after the LEDs have been soldered. When repair is unavoidable, suitable tools must be used.
3. Die slug is to be soldered.
4. When soldering, do not put stress on the LEDs during heating.
5. After soldering, do not warp the circuit board.

### Notes on Lightning EMC Series soldering:

1. Recommend to use reflow machine.
2. Recommend to use heating plate soldering.
3. Manual soldering is not recommended.

### Notes on reflow process:

1. To confirm whether the actual temperature curve in the reflow soldering conditions comply with recommended conditions. LEDs are guaranteed for one time reflow.
2. During reflow process do not apply force on LED active area.
3. After reflow process, PCB board should be cooled down before packing or storage.

## Pre-caution for use (注意事项)

---

### 注意:

1. 回流焊建议不要超过两次。
2. LED焊接后不建议重工。当重工不可避免时,必须使用合适的工具。
3. 不可虚焊。
4. 焊接加热过程中,请勿施加压力于LED表面。
5. 焊接后,请勿弯曲电路板。

### 焊接注意事项:

1. 建议使用回流焊机器。
2. 建议使用加热板焊接。
3. 不建议手动焊接。

### 回流焊注意事项:

1. 确保实际温度曲线与回流焊接条件相符合。
2. 在回流过程中, 请勿施加压力于LED表面。
3. 回流后,PCB板在包装或存储前需冷却至常温。